

1D Laser Barcode Scanner

Quick Start Guide



- Contents:
- Barcode Scanner
 - Quick Start Guide
 - warranty card
 - Certificate
 - USB / RS232 Cable
 - Power Adapter (RS232)

No. : 75050110

1 scanner overview

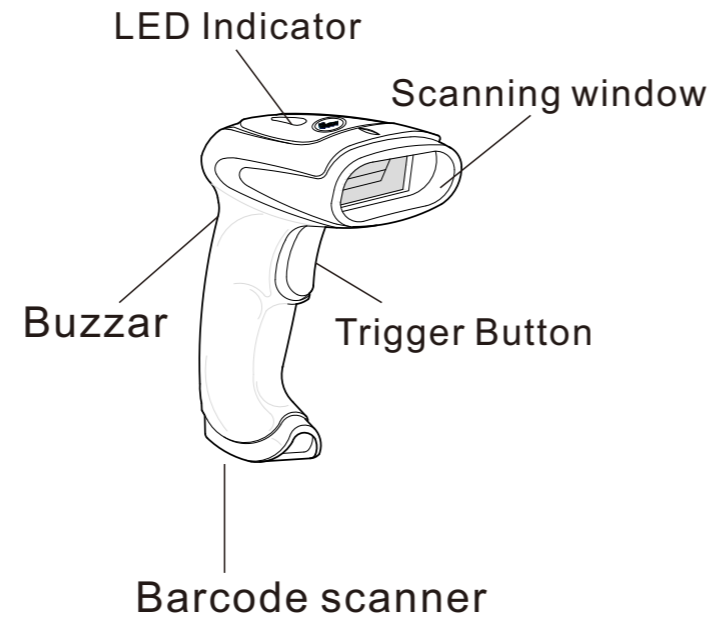

2 Cable plug&unplug

(Pluggable scanner applies)

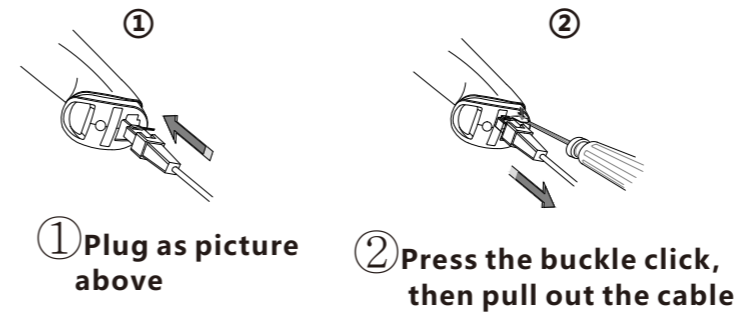

3 Data cable connection Guide

(1).USB cable

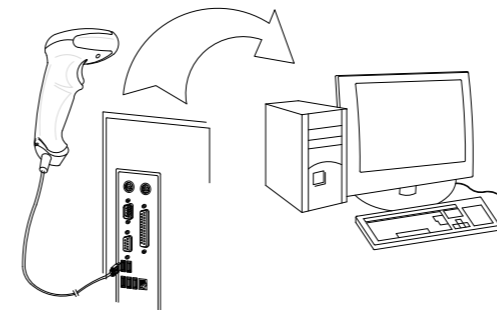

(2).RS232 cable

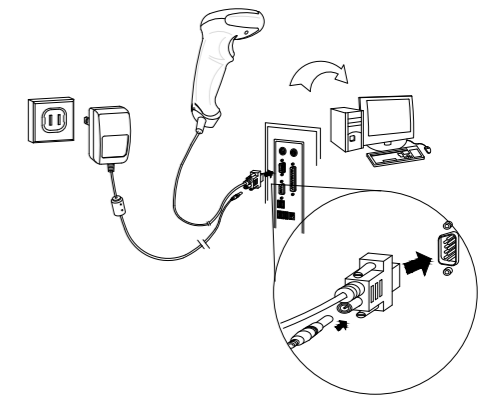

(3).RS485 cable

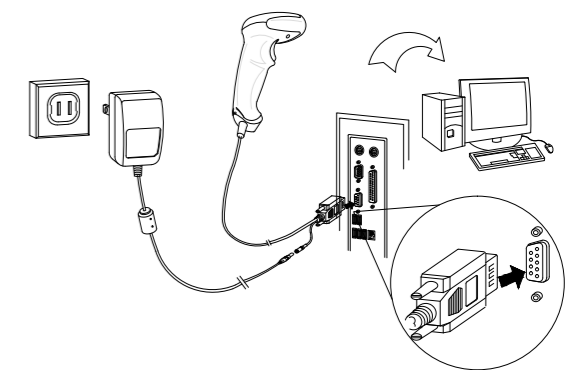

4 Scanning angle

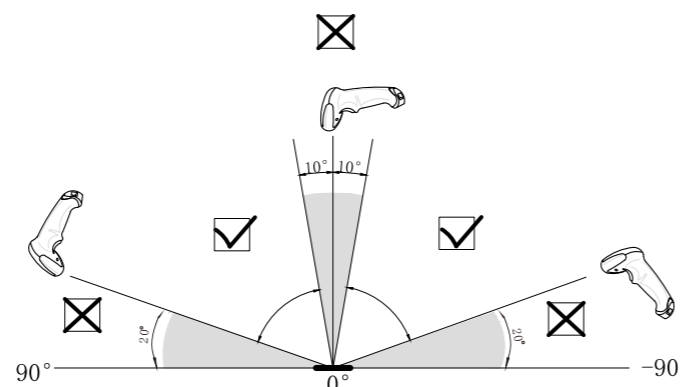

5 Methods and distance

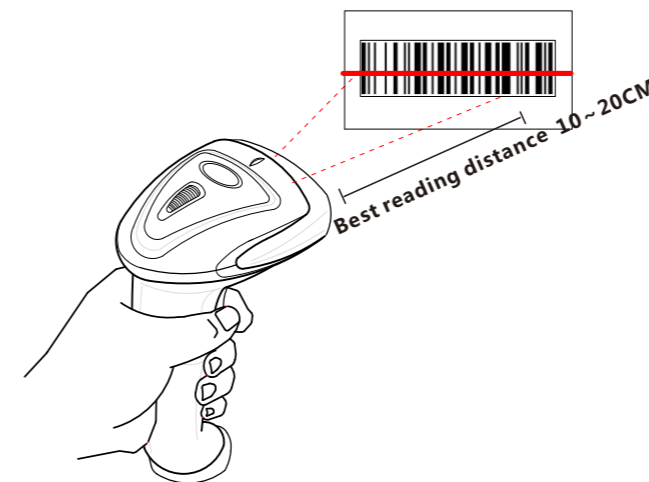

Correct



Wrong



NOTE: Laser beam should be full covered on the bar code

Lights Indicator

LED Indicator	Explanation
Blue lights blinking	Decoding Successfully
Red light On	Standby status

Buzzer

Beep Indication	Explanation
One Beep	Decoding Successfully
Three Beep	USB Data transfer failed
Four Beep	Power on
Continuous Beep	Successfully parameter setting

Troubleshooting Q&A:

- Q1: USB barcode scanner with "beep beep beep" after scanning and no data uploaded.
A1: Unplug and plug the scanner into another USB port.
- Q2: USB barcode scanner without data upload and alarm buzzer after scanning.
A2: Restore factory default.
- Q3: No laser beam after connection via RS232.
A3: Refer to Data cable connection guide and check the power supply
- Q4: No data upload and alarm buzzer after scanning via Rs232.
A4: Terminal should have software to transfer data when using RS232, not cursor position.
- Q5: How to set barcode data with increase and decrease digits when scanning barcodes?
A5: Refer to barcode settings as ⑨ and ⑩, ⑪ to set the scanner.

Barcode settings

Setting Step

1

Scan the barcode of "Enter setting"



Enter setting (%SET)



2

Scan function bar code
(Support multiple scanning setting barcodes)



Disable repeat reading same barcode



0x0D as suffix



3

Scan "Exit and Save" Bar code



Exit and save (%END)

Note: All functions must be in accordance with the settings for The above process or scan the bar code setting function is invalid.

① Restore factory default



Restore factory defaults (DF)

Note: 1. Restore factory default will not change interface Mode.Refer to Interface Mode Selection for setting interface
2. With "*" in bold means factory default parameter.

② Interface Mode Selection

Setting step as below with function barcodes when using RS232 to transfer data



Serial Output (A000)

Note: Terminal should have software to transfer data when using RS232,not cursor position.

Setting step as below with function barcodes when using USB to transfer data



*USB HID Keyboard (A001)

Setting step as below with function barcodes when using RS485 to transfer data



RS485 (A004)

③ Auto trigger (optional)



Disable auto trigger (H000)



* Enable auto trigger (H0001)

④ Trigger Mode



*Single Read (F000)



Continuous Read (F0001)

Single read: when a bar code has been decoded, the reader will be turned off. The reader must be triggered again to read another label.

Continuous: The reader will produce as much data as it can decode regardless whether it is the same or not. This mode is mainly used for demonstration and diagnosis.

⑤ Reading Mode



Disable repeat read (F0100)



*Enable repeat read (F0101)



Multiple read (F0102)

Disable repeat read: Disable continue to read the same barcode.

Multiple read: The same label can only be decoded again after the label has not been detected for a number of scans. This mode can only be programmed in Continuous read trigger mode.

⑥ Repeat the same bar code reading interval



*0ms (F0200)



500ms (F0205)



1000ms (F0210)

⑦ Set Suffix



Disable suffix (J2000)



*0x0D as suffix (J2001)



0x0D 0x0A as suffix (J2003)

⑧ Version Reading



Version Reading (RV)

⑨ Code 39 Setting



Transmit ST/SP (IF101)



*Not Transmit ST/SP (IF100)

⑩ UPC Setting



Enable UPC-E convert to UPC-A (ID100)



*Disable UPC-E convert to UPC-A (ID101)



Enable UPC-A convert to EAN-13 (IA101)



*Disable UPC-A convert to EAN-13 (IA100)

⑪ Delete some bar code



*Disable deleting start character (K0200)



*Disable deleting end character (K0300)



Delete start one character (K0201)



Delete start two characters (K0202)



Delete end one character (K0301)



Delete end two characters (K0302)